

GAMBAR RENCANA



PEMERINTAH PROVINSI SUMATERA BARAT
**DINAS BINA MARGA, CIPTA KARYA,
 dan TATA RUANG**
 JL. TAMAN SISWA NO. 01 PADANG TELP.0751-7051700 / 7051758

PROGRAM : PENYELENGGARAAN JALAN PROPINSI
 SUB KEGIATAN : PENYUSUNAN RENCANA, KEBIJAKAN, STRATEGI PEMBANGUNAN JALAN
 SERTA PERENCANAAN TEKNIS PENYELANGGARAN JALAN DAN JEMBATAN
 PAKET : CORE TEAM PERENCANAAN DAN PENDAMPINGAN TEKNIS BINA MARGA
 SUB PEKERJAAN : DESAIN PENANGANAN BENCANA / MENDESAK JALAN TERBAN MANGGOPOH -
 PADANG LUAR (P.025)
 LOKASI TAHUN : NAGARI SUNGAI LANDIA KIL. 160-100 & KIL. 160+950
 : 2023

PT. LARAS SEMBADA
 Architects - Engineering and Management Consultant



CORE TEAM
 DISUSUNAKAN : [Signature]
 DIPERIKSA : [Signature]
 ALYAN, BT
 Y. KURNIAWATI, S.T.P., MT
 I. RIZKI

JUDUL GAMBAR : SITUASI

SKALA

NOMOR
LEMBAR

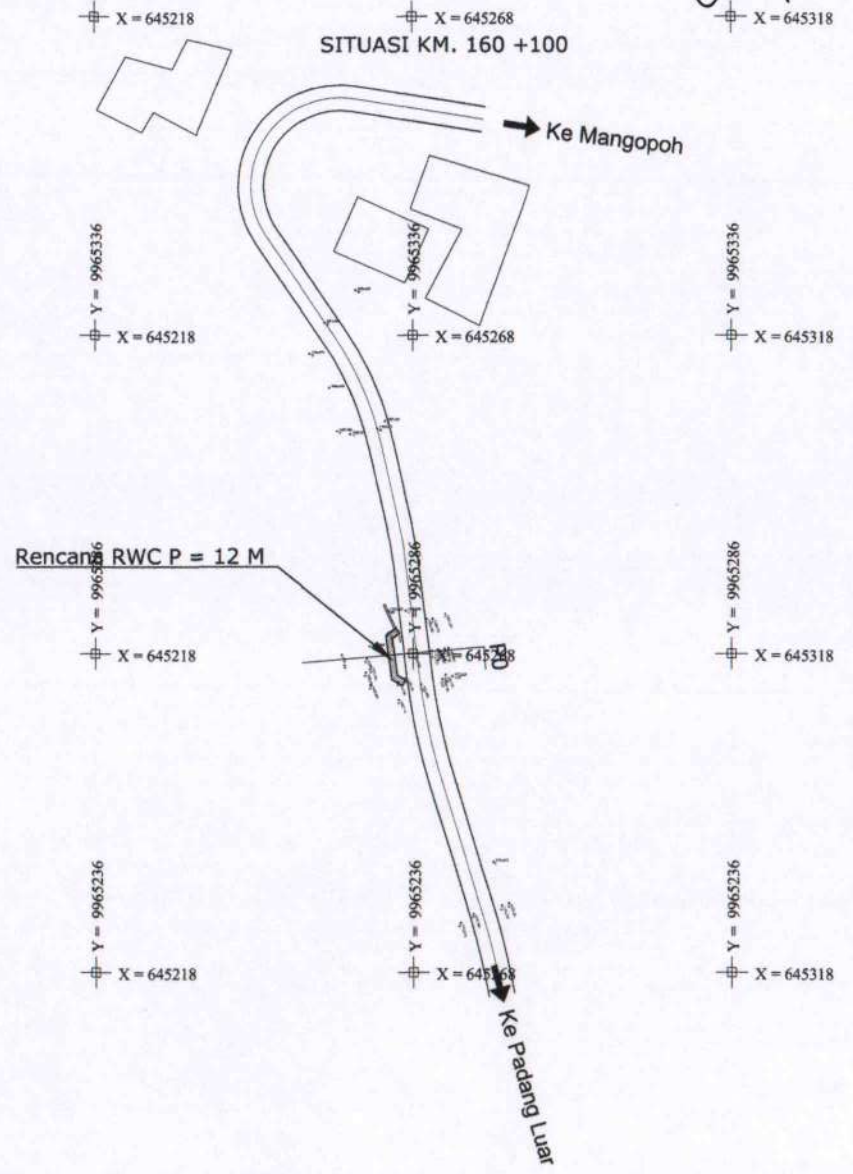



PEMERINTAH PROVINSI SUMATERA BARAT
DINAS BINA MARGA, CIPTA KARYA DAN TATA RUANG

Jalan Taman Siswa No. 1 Telp. (0751) 7051756 Fax. (0751) 7051783 Padang

LEMBAR PENGESAHAN

LOKASI : RUAJ JALAN MANGGOPOH - PADANG LUA (P.025)

TIM TEKNIS BIDANG KEBINAMARGAAN TAHUN 2023

NO.	NAMA	JABATAN	PADA TTD
1	JOKO SISWOYO, ST, MT	KETUA	
2	JULIA ANDRINI BEPADI, ST, MT	SEKRETARIS	
3	TIBO GONREI	ANGGOTA	
4	MARZUKI, ST	ANGGOTA	
5	ALVIN PRATAMA, ST	ANGGOTA	
6	JULMASEI, ST	KONSULTAN INDIVIDU	

MENGETAHUI OLEH :

KABID DINAMARGA
DINAS BINA MARGA, CIPTA KARYA DAN TATA RUANG
PROVINSI SUMATERA BARAT

ADRATUS SETIAWAN, ST, MT
Nip. 19710910 200604 1 007

DIKETAHUI/DISETUIJI OLEH :

PEJABAT PEMBUAT KOMITMEN (PPKom)
DINAS BINA MARGA, CIPTA KARYA DAN TATA RUANG
PROVINSI SUMATERA BARAT

HARNESIA WIRDA, ST, MT
Nip. 19640809 201403 2 001





FEMERINTAH PROVINSI SUMATERA BARAT
DINAS DINA MARGA, CIPTA KARYA DAN TATA RUANG
Jalan Theroa Sema No. 1 Padang, (075) 1951199 Pns. (075) 195239 Padang

PEKERJAAN : PERENCANAAN TEKNIS PEKERJAAN MENDESAK DAN BENCANA ALAM
LOKASI : RUJAS JALAN MANGGOPH - PADANG LUAR (P.025)

Provinsi :
Sumatra Barat
Lokasi :
RUJAS JALAN MANGGOPH - PADANG LUAR (P.025)

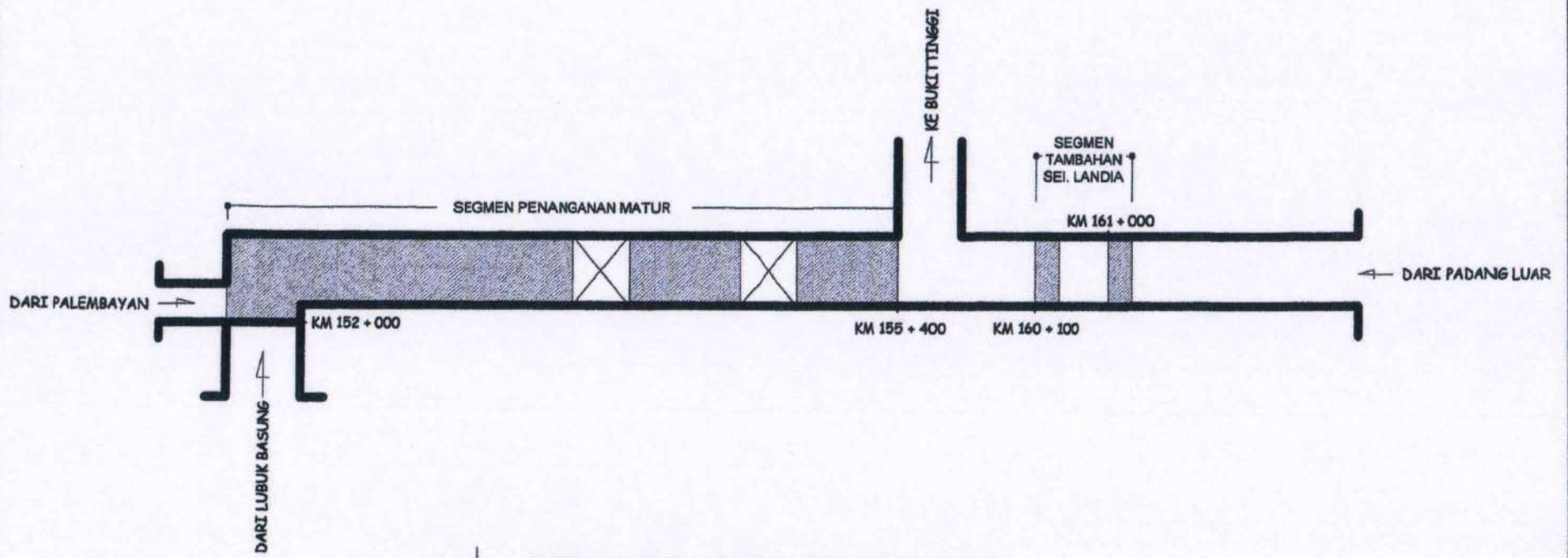
No. Lembar :
2023
Tahun :
2023



 STRIP MAP LOKASI PENANGANAN



PEMERINTAH PROVINSI SUMATERA BARAT
DINAS BINA MARGA, Cipta Karya dan Tata Ruang

Jalan Terasa Selo No. 1 Telp. (0751) 7011256 Fax. (0751) 7011783 Padang

PEKERJAAN : PERENCANAAN TEKNIS PEKERJAAN HENDAK DAN BENCANA ALAM

LOKASI : RUMAH JALAN MANGGOPOH - PADANG LIA (P.028)

Provinsi :

Sumatra Barat

Lokal :

RUMAH JALAN MANGGOPOH - PADANG LIA
(P.028)

[Signature]
KOR. SUMATERA BARAT

[Signature]
SUMBAR

Judul Gambar :

SEGMENT -3
KM 154+150 S/D 157+650 = 3,00 KM

Skala :

1 : 2023

Sheet :

1:7200

CATATAN:

- PENGUKURAN SAMBAR INE DIBUAT DENGAN MENGGUNAKAN TRACKING GPS DAN GOOGLE EARTH
- UNTUK PELAKSANAAN TENDER FISIK NANTINYA HARAPKAN DILAKUKAN PERENCANAAN LEBIH DETAIL

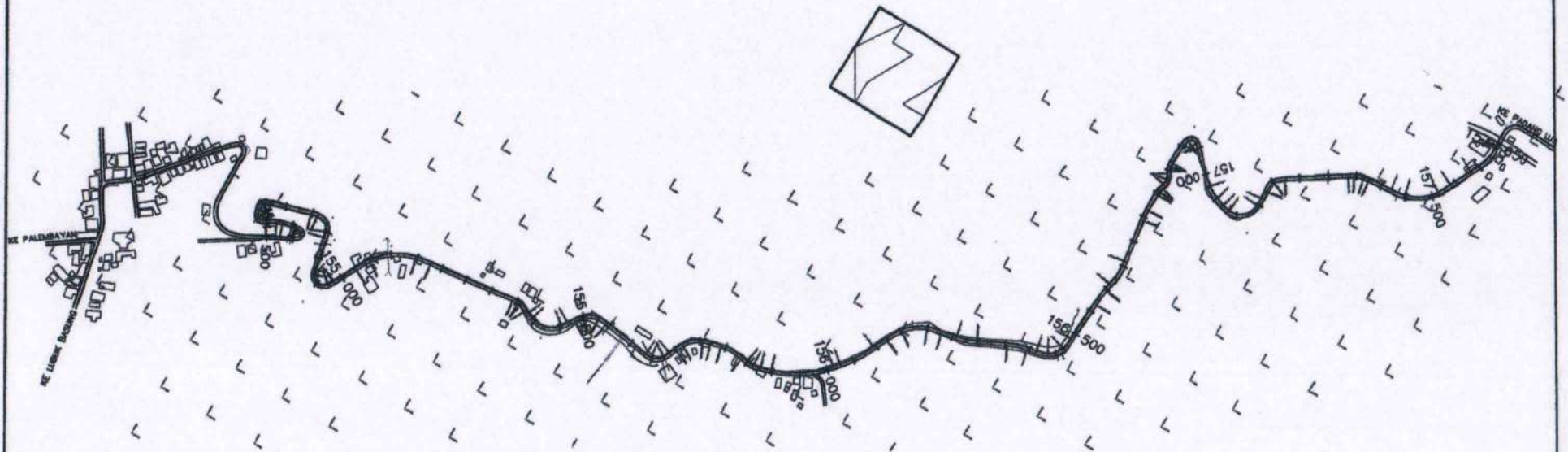



PEMERINTAH PROVINSI SUMATERA BARAT
DINAS BINA MARGA, Cipta Karya dan Tata Ruang
Jalan Yansen Utama No. 1 Telp. (0751) 361199 Fax. (0751) 781780 Padang

PEKERJAAN : PERENCANAAN TEKNIS PEKERJAAN MENDESAK DAN BENCANA ALAM
LOKASI : RUAB JALAN MANGGOPOH - PADANG LIA (P.025)

Propnal :
Sumatra Barat
Lokasi :
RUAB JALAN MANGGOPOH - PADANG LIA (P.025)

Disetujui Oleh:
[Signature]
[Signature]

Judul Gambar :
PLAN DAN PROFIL

No Lembar : 1
Tahun : 2023
Skala : 1:200; h=1:1000

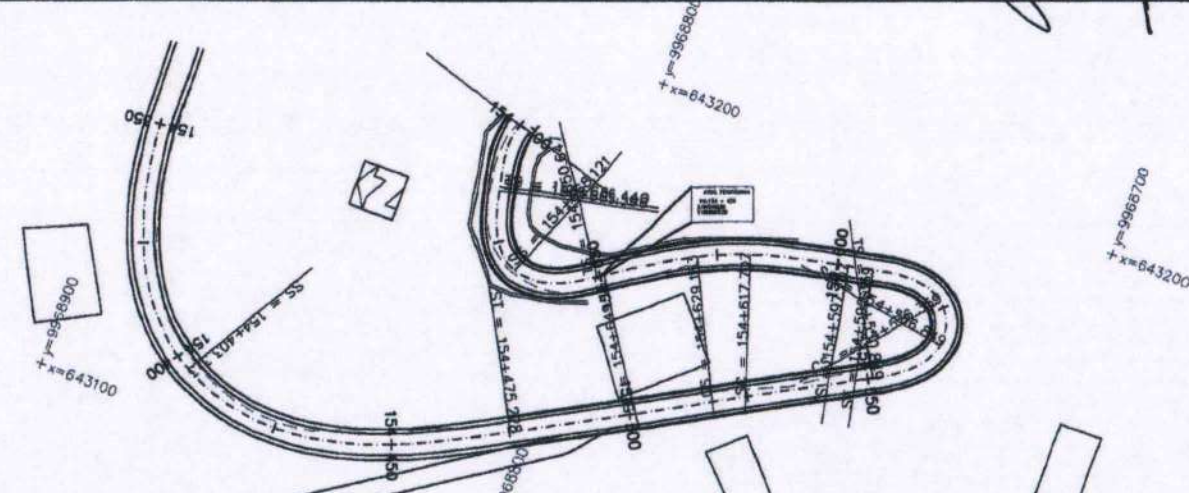

PI	1
S	S-5
Sta	154+678.270
X	643144.284
Y	9968018.324
Δ	111+14+43
V	30
R	9
Ls	17.476
Es	-
7s/7e	23.823
Ea/Es	0.3901
Ls	-
L	-
e	0.01

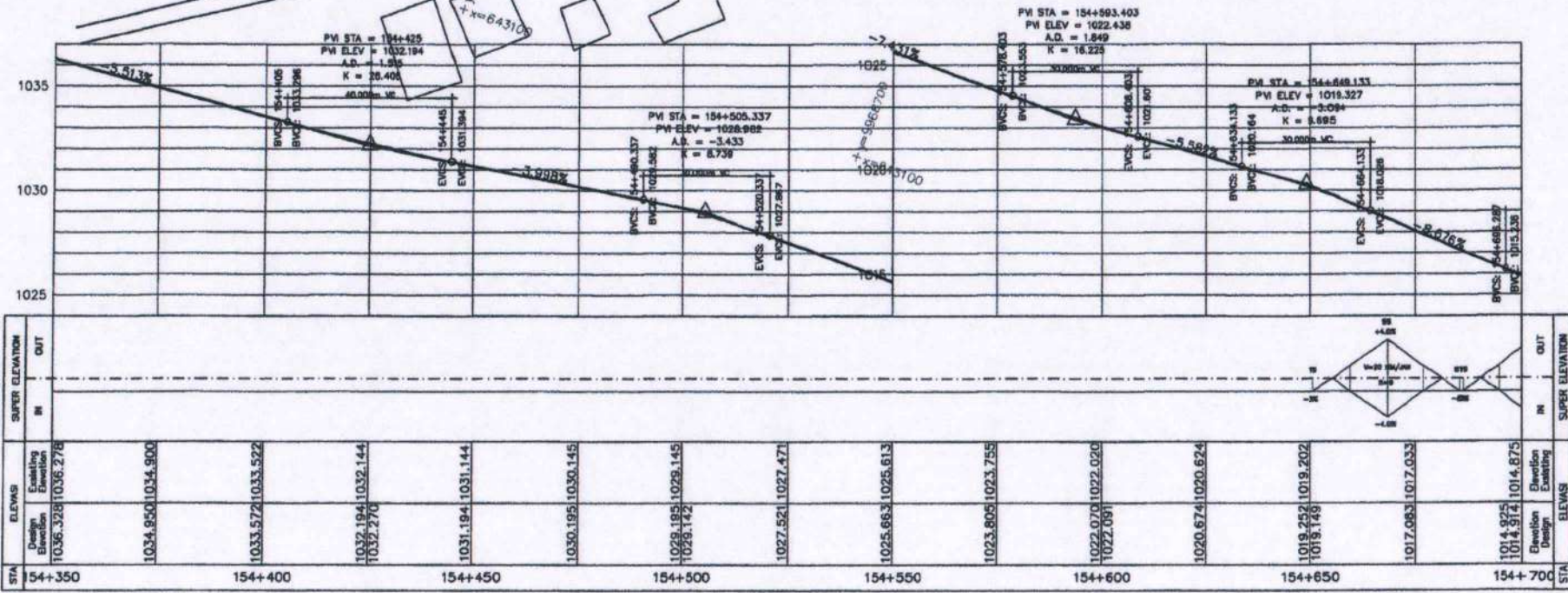



Survei
Desain
AMR/AL/ET
AMR/AL/ET

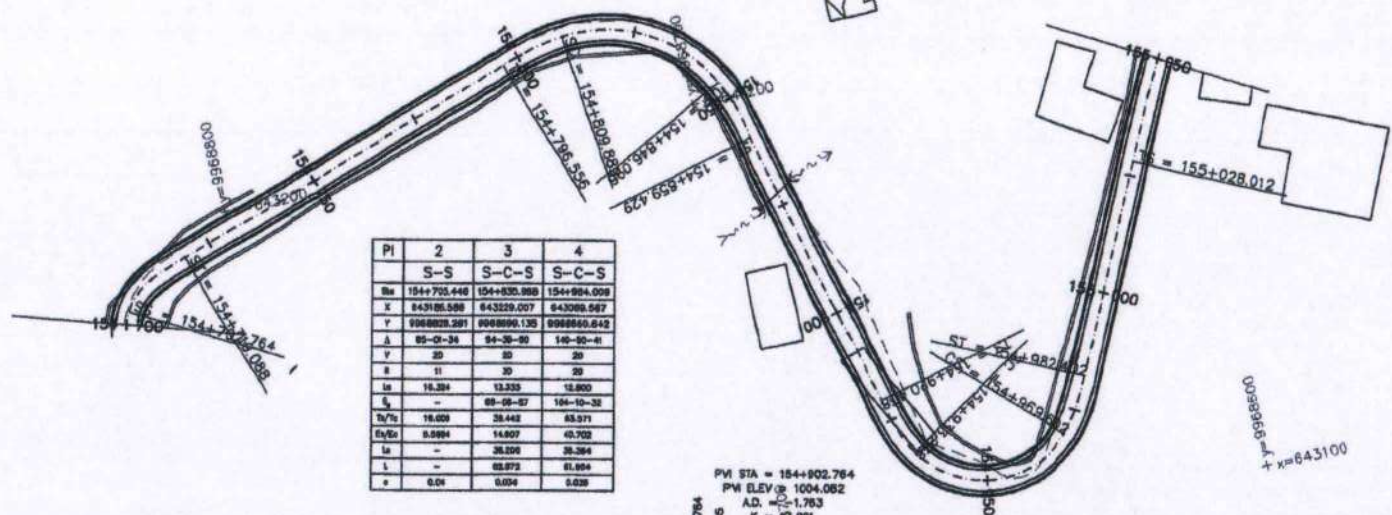

PI	2	3	4
	S-S	S-C-S	S-C-S
Ra	154+703.448	154+830.888	154+924.028
K	843186.588	843229.007	843089.987
Y	8988028.281	8988898.138	8988840.642
A	85-02-34	84-25-50	140-10-41
V	20	20	20
R	11	20	20
la	18.384	12.235	12.800
S	-	88-08-87	166-10-38
Ta/Ts	18.009	28.442	43.971
Ea/Es	8.8984	14.807	47.702
la	-	28.206	28.284
L	-	82.872	81.804
e	0.04	0.004	0.028

PVI STA = 154+711.287
PVI ELEV = 1013.934
A.D. = 4.747
K = 6.319

PVI STA = 154+902.764
PVI ELEV = 1004.082
A.D. = -1.763
K = 92.021

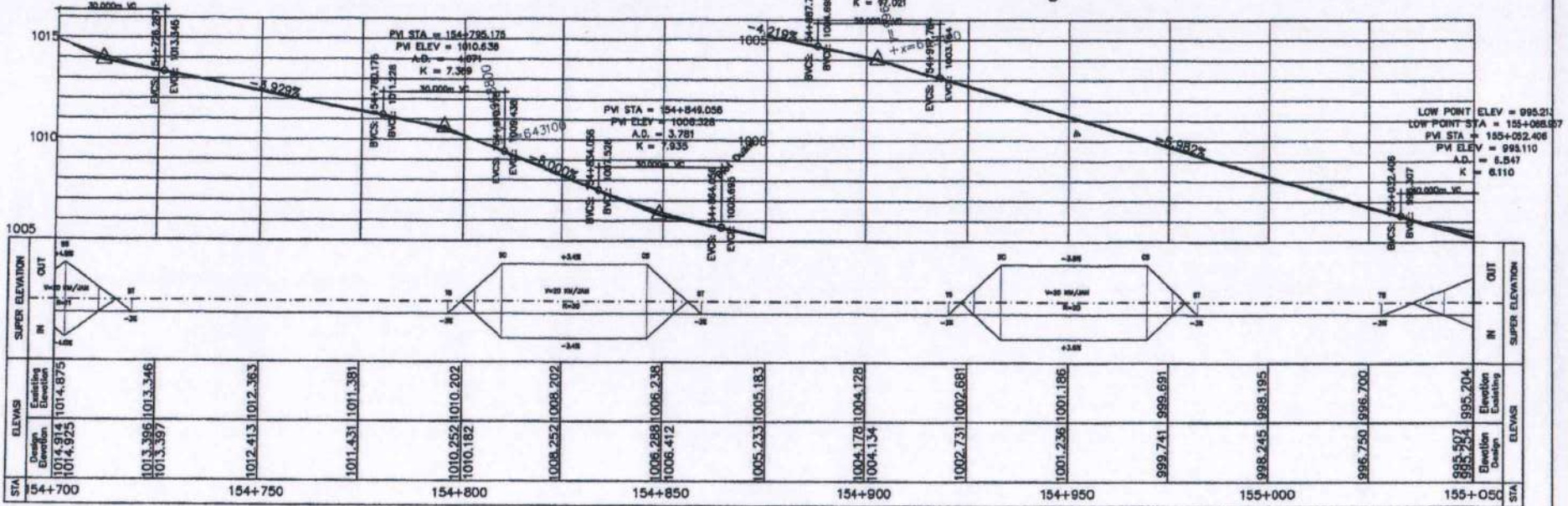

STA	ELEVASI	Super Elevation	IN	OUT	Super Elevation	IN	OUT
154+700	1014.914 1014.925	1014.875					
154+750	1013.396 1013.397	1013.346					
154+800	1010.252 1010.182	1012.363					
154+850	1006.288 1006.412	1006.238					
154+900	1004.178 1004.134	1005.183					
154+950	999.741	1002.681					
155+000	998.245	998.195					
155+050	995.507 995.254	995.204					



PEMERINTAH PROVINSI SUMATERA BARAT
DINAS BINA MARGA, CIPTA KARYA DAN TATA RUANG
Jalan Teras Utama No. 1 Telp. (075) 781334 Fax. (075) 781782 Padang

PEKERJAAN : PERENCANAAN TEKNIS PEKERJAAN HENDAK DAN BENCANA ALAM
 LOKAS : RUAS JALAN MANGIOPOH - PADANG LUA (P.028)

Propinsi :
 Sumatra Barat
 Lokasi :
 RUAS JALAN MANGIOPOH - PADANG LUA
 (P.028)

Survei Hidrografi dan Hidrolika
 No. 100/2023
 No. 100/2023
 No. 100/2023

PLAN DAN PROFIL

No. Lembar :
 3
 Tahun :
 2023
 Skala :
 1:200; h:1:1000

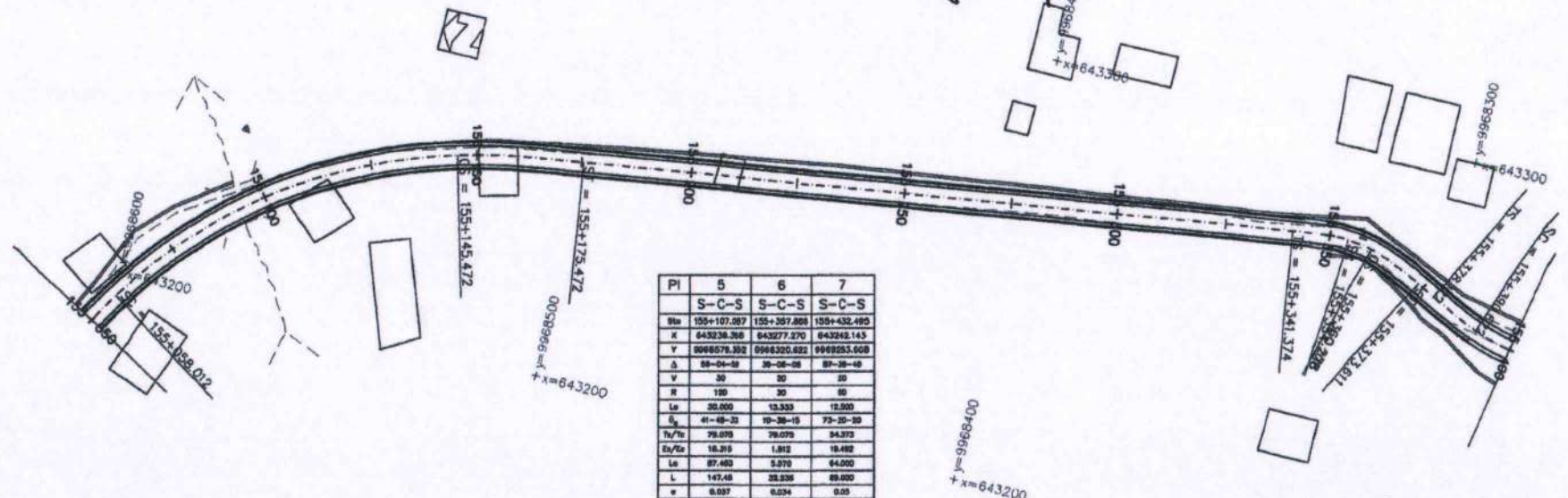

PI	5	6	7
	S-C-S	S-C-S	S-C-S
Sta	155+107.087	155+307.808	155+432.493
X	643238.356	643277.270	643242.143
Y	9968578.302	9968320.622	9968253.008
Δ	55-04-49	30-08-08	87-28-48
V	30	30	30
R	120	30	60
Le	20.000	13.333	12.500
Δ ₁	41-49-33	10-38-19	73-20-30
T ₁ /T ₂	78.078	78.078	34.373
E ₁ /E ₂	18.316	1.812	18.482
L ₁	87.480	5.070	64.000
L	147.48	33.936	89.000
w	0.097	0.034	0.03

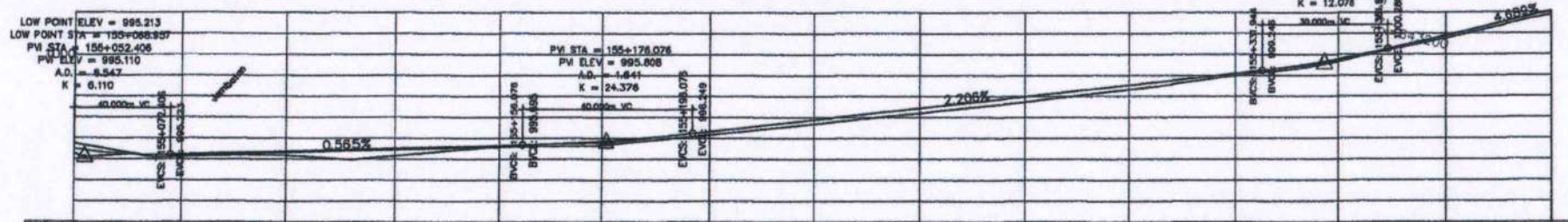

STA	SUPER ELEVATION		ELEVATIONS
	IN	OUT	
155+050	-3.78	3.78	Design Elevation: 995.254, 995.507; Existing Elevation: 995.204
155+100	-3.78	3.78	Design Elevation: 995.238, 995.188; Existing Elevation: 995.188
155+150	-3.78	3.78	Design Elevation: 995.379, 995.329; Existing Elevation: 995.329
155+200	-3.78	3.78	Design Elevation: 995.520, 995.470; Existing Elevation: 995.470
155+250	-3.78	3.78	Design Elevation: 995.661, 995.611; Existing Elevation: 995.611
155+300	-3.78	3.78	Design Elevation: 995.802, 995.752; Existing Elevation: 995.752
155+350	-3.78	3.78	Design Elevation: 996.336, 996.286; Existing Elevation: 996.286
155+400	-3.78	3.78	Design Elevation: 996.887, 996.837; Existing Elevation: 996.837
155+450	-3.78	3.78	Design Elevation: 997.439, 997.389; Existing Elevation: 997.389
155+500	-3.78	3.78	Design Elevation: 997.990, 997.940; Existing Elevation: 997.940
155+550	-3.78	3.78	Design Elevation: 998.541, 998.491; Existing Elevation: 998.491
155+600	-3.78	3.78	Design Elevation: 999.093, 999.043; Existing Elevation: 999.043
155+650	-3.78	3.78	Design Elevation: 999.720, 999.670; Existing Elevation: 999.670
155+700	-3.78	3.78	Design Elevation: 1000.347, 1000.297; Existing Elevation: 1000.297
155+750	-3.78	3.78	Design Elevation: 1000.993, 1000.943; Existing Elevation: 1000.943
155+800	-3.78	3.78	Design Elevation: 1001.640, 1001.590; Existing Elevation: 1001.590
155+850	-3.78	3.78	Design Elevation: 1002.287, 1002.237; Existing Elevation: 1002.237
155+900	-3.78	3.78	Design Elevation: 1002.934, 1002.884; Existing Elevation: 1002.884
155+950	-3.78	3.78	Design Elevation: 1003.581, 1003.531; Existing Elevation: 1003.531
156+000	-3.78	3.78	Design Elevation: 1004.228, 1004.178; Existing Elevation: 1004.178



PEMERINTAH PROVINSI SUMATERA BARAT
DINAS BINA MARGA, CIPTA KARYA DAN TATA RUANG

Jalan Tolong Raya No. 1 Telp. (0751) 7027799 Fax. (0751) 7017750 Padang

PEKERJAAN : PERENCANAAN TEKNIS PEKERJAAN HENDAK DAN BENCANA ALAM

LOKASI : RUAS JALAN MANGGOPH - PADANG LUA (P.028)

Propinsi :
Sumatra Barat
Lokasi :
RUAS JALAN MANGGOPH - PADANG LUA
(P.028)

Peny. Survey Peta dan Ukur dan Binaan Jalan
No. 1000/2000/2000
No. 1000/2000/2000

PLAN DAN PROFIL

No. Lembar : 4
Tahun : 2023
Skala :
v=1:200;h=1:1000

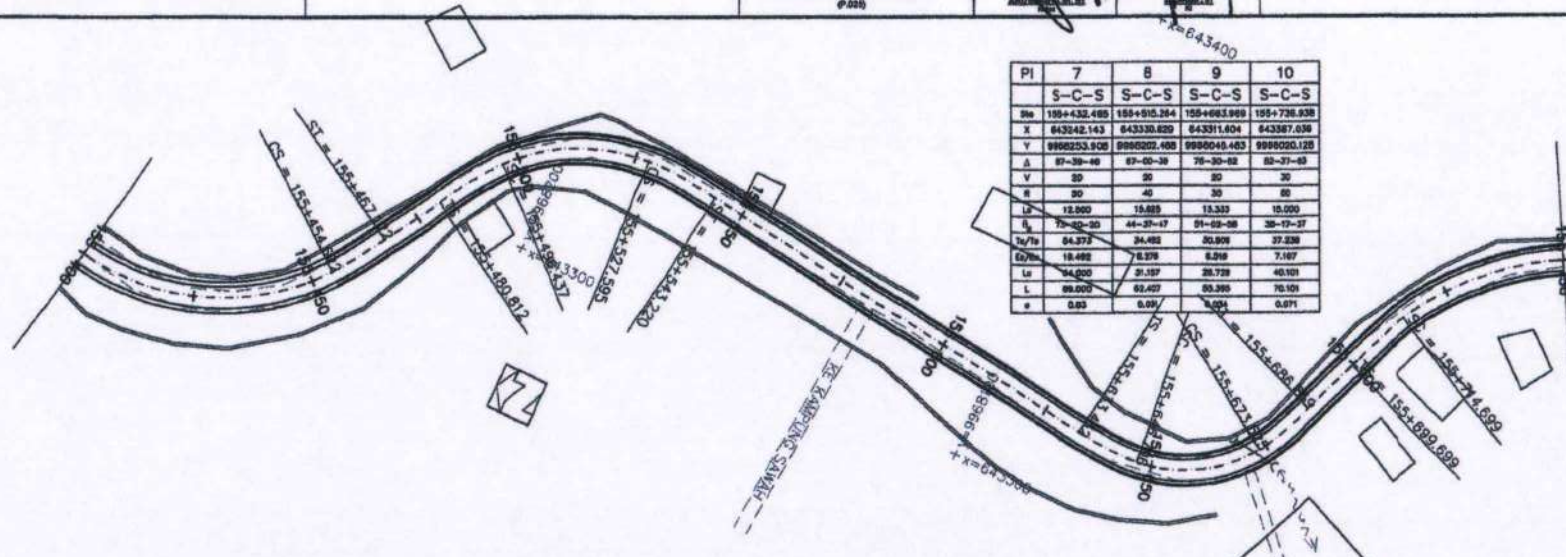

PI	7	8	9	10
	S-C-S	S-C-S	S-C-S	S-C-S
Pk	199+432.485	188+915.354	158+663.999	105+778.938
X	642042.143	643330.820	643311.404	643287.076
Y	9998253.908	9998202.408	9998048.463	9998020.128
Δ	87-39-00	87-00-30	78-30-02	82-37-03
V	20	20	20	20
H	20	20	20	20
L _r	12.000	10.000	13.333	15.000
L _s	78-00-30	44-30-17	51-00-38	38-17-37
T _o /T _s	84.373	34.452	30.907	37.238
E _o /E _s	18.482	7.878	8.818	7.187
L	89.000	62.427	69.300	70.101
e	0.82	6.09	7.051	0.671

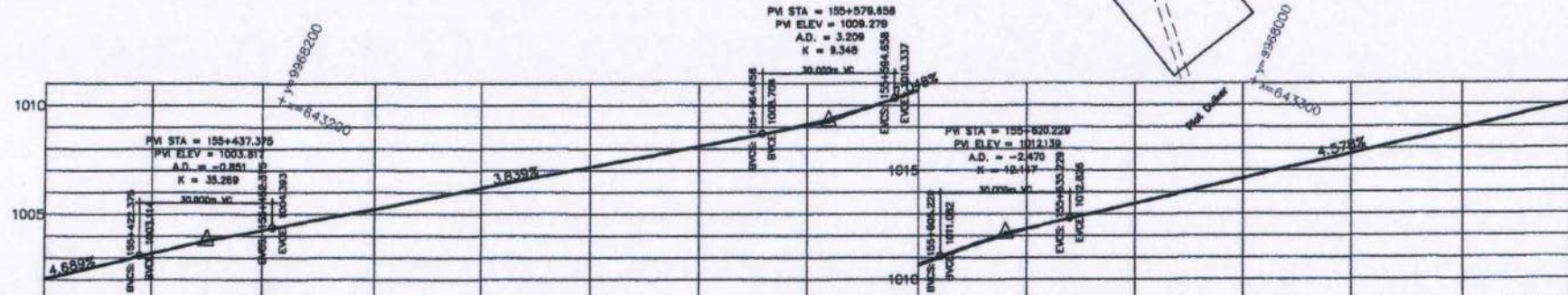

STA	SUPER ELEVATION		ELEVATIONS	STA
	IN	OUT		
155+400	+3.00	-3.00	Design Elevation: 1002.065 Existing Elevation: 1002.015	155+400
155+450	+3.00	-3.00	Design Elevation: 1003.237 Existing Elevation: 1003.187	155+450
155+500	+3.00	-3.00	Design Elevation: 1004.302 Existing Elevation: 1004.252	155+500
155+550	+3.00	-3.00	Design Elevation: 1005.262 Existing Elevation: 1005.212	155+550
155+600	+3.00	-3.00	Design Elevation: 1006.221 Existing Elevation: 1006.171	155+600
155+650	+3.00	-3.00	Design Elevation: 1007.181 Existing Elevation: 1007.181	155+650
155+700	+3.00	-3.00	Design Elevation: 1008.141 Existing Elevation: 1008.091	155+700
155+750	+3.00	-3.00	Design Elevation: 1009.101 Existing Elevation: 1009.051	155+750



PI	15	16	17	18
	S-C-S	F-C	F-C	S-C-S
Sta	156+177.880	156+277.240	156+373.104	156+404.601
X	643824.474	643846.641	643691.019	643706.124
Y	9967891.141	9967907.376	9967902.040	9967422.062
Δ	94-44-07	15-12-22	15-17-03	77-39-02
V	30	30	30	30
R	80	180	180	40
Ls	31.350	-	-	22.590
Δs	25-27-19	-	-	45-25-18
Ts/Te	97.979	20.023	28.148	43.833
Ca/Ce	10.654	1.320	1.347	12.016
La	45.175	32.816	46.090	31.710
L	107.975	-	-	75.710
e	0.026	LM	LM	0.021

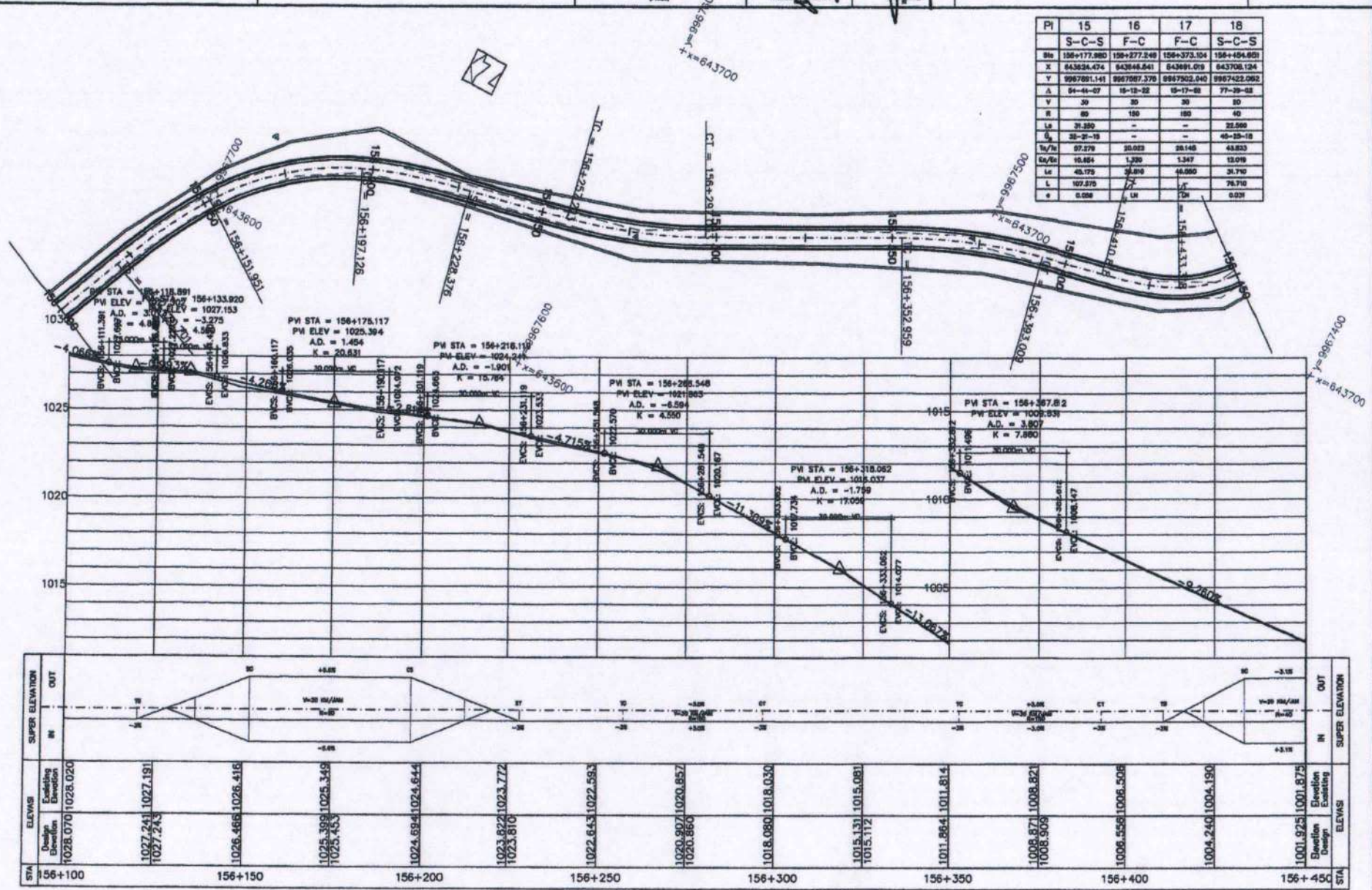



PEMERINTAH PROVINSI SUMATERA BARAT
DINAS BINA MARGA, Cipta Karya dan Tata Ruang
Jalan Pemuda No. 174, (091) 7991799 Fax. (0913) 7991783 Padang

PEKERJAAN : PERENCANAAN TEKNIS PEKERJAAN MENDEKAT DAN BENCANA ALAM
 LOKASI : RUAS JALAN MANDOGOPH - PADANG LIA (P.025)

Propinsi :
 Sumatera Barat
 Lokasi :

RUAS JALAN MANDOGOPH - PADANG LIA
 (P.025)

PLAN DAN PROFIL

No Lembar: 7
 Tahun: 2023
 Skala: v=1:200; h=1:1000

PI	18	19	20	21
	S-C-S	F-C	F-C	F-C
Sta	156+454.931	156+579.929	156+634.441	156+733.029
X	643706.124	643844.364	643898.188	644016.801
Y	9967422.002	9967421.403	9967412.379	9967432.039
Δ	77-20-02	9-14-37	19-01-36	8-02-09
V	20	30	30	30
R	40	150	150	150
Ls	22.800	-	-	-
B	49-25-19	-	-	-
Ts/Tr	43.633	16.168	25.137	10.990
Es/Er	12.019	0.802	2.092	0.379
Lc	31.710	22.396	46.619	27.037
L	76.710	-	-	-
e	0.831	LH	LH	LH

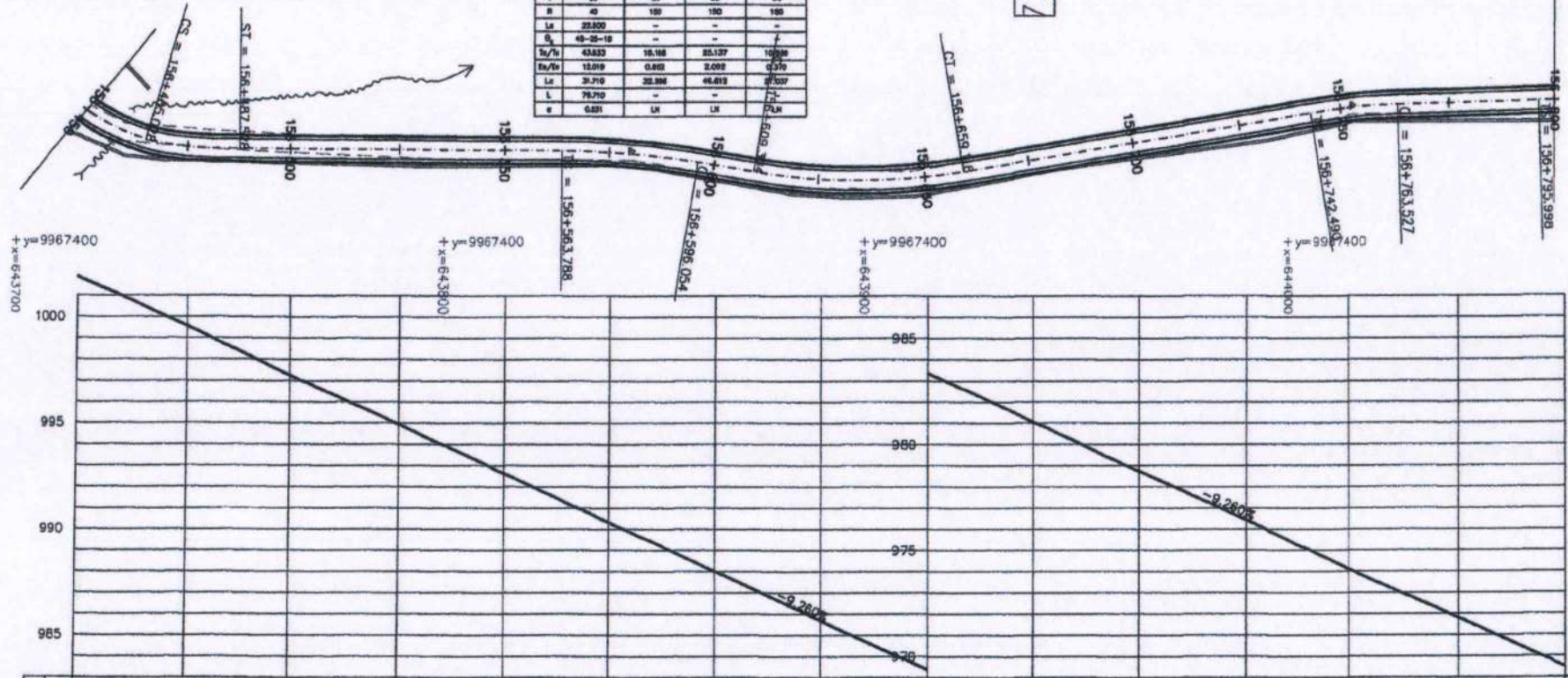

STA	ELEVASI		SUPER ELEVATION	ELEVATION
	Design Elevation	Existing Elevation		
156+450	1001.925	1001.875	IN	OUT
156+500	999.610	999.560	IN	OUT
156+550	997.295	997.245	IN	OUT
156+600	994.980	994.930	IN	OUT
156+650	992.665	992.615	IN	OUT
156+700	990.350	990.300	IN	OUT
156+750	988.035	987.985	IN	OUT
156+800	985.720	985.670	IN	OUT
	983.405	983.355	IN	OUT
	981.089	981.039	IN	OUT
	978.774	978.724	IN	OUT
	976.459	976.409	IN	OUT
	974.144	974.094	IN	OUT
	971.829	971.779	IN	OUT
	969.514	969.464	IN	OUT
	967.199	967.149	IN	OUT



PEMERINTAH PROVINSI SUMATERA BARAT
DINAS BINA MARGA, CPTA KARYA DAN TATA RUANG
 Jalan Thammas Biraha No. 1 Telp. (0751) 7001790 Fax. (0751) 7001793 Padang

PEKERJAAN : PERENCANAAN TEKNIS PEKERJAAN HENDAK DAN BENCANA ALAM
 LOKASI : RUAS JALAN MANGGOPOH - PADANG LUA (P.028)

Propinsi :
 Sumatra Barat
 Lokasi :
 RUAS JALAN MANGGOPOH - PADANG LUA
 (P.028)

No. Tahap Survey / Revisi Mendahului Rencana Akhir
 Disetujui Oleh :
 (Signature)
 (Signature)

PLAN DAN PROFIL

No Lembar : 10
 Tahun : 2023
 Skala : v=1:200;h=1:1000

PI	30	31
	S-C-S	F-C
Bla	157+483.889	157+616.602
X	644295.126	644426.829
Y	9967003.073	9968941.851
Δ	30-03-28	30-04-43
V	30	30
R	90	90
La	27.776	30.000
B ₁	41-22-24	
B ₂	33.059	32.243
B ₃	13.845	4.228
L ₀	64.869	62.868
L	120.545	-
e	0.880	0.837

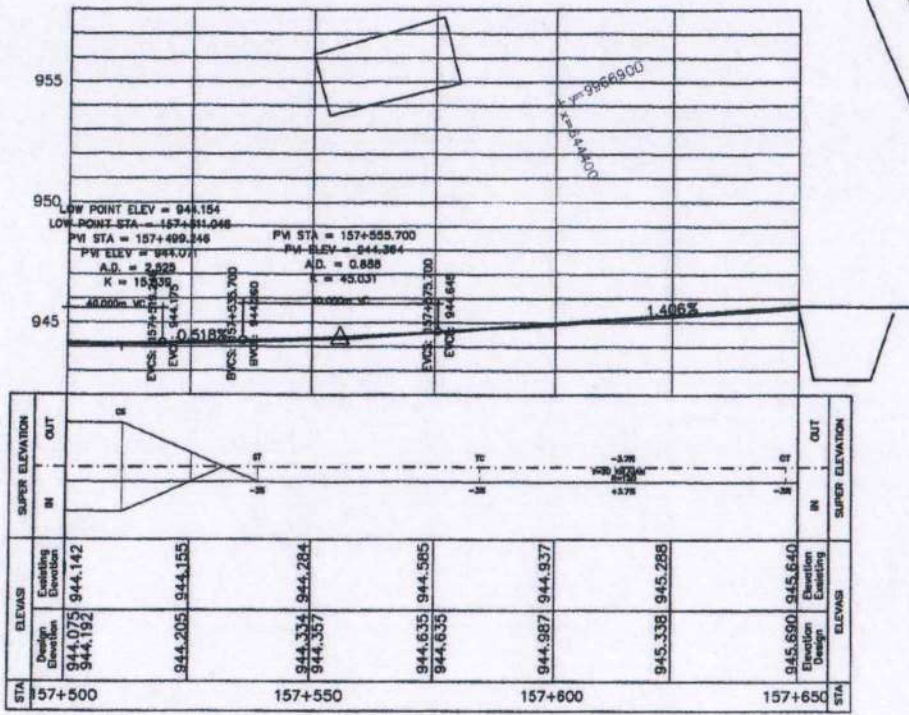
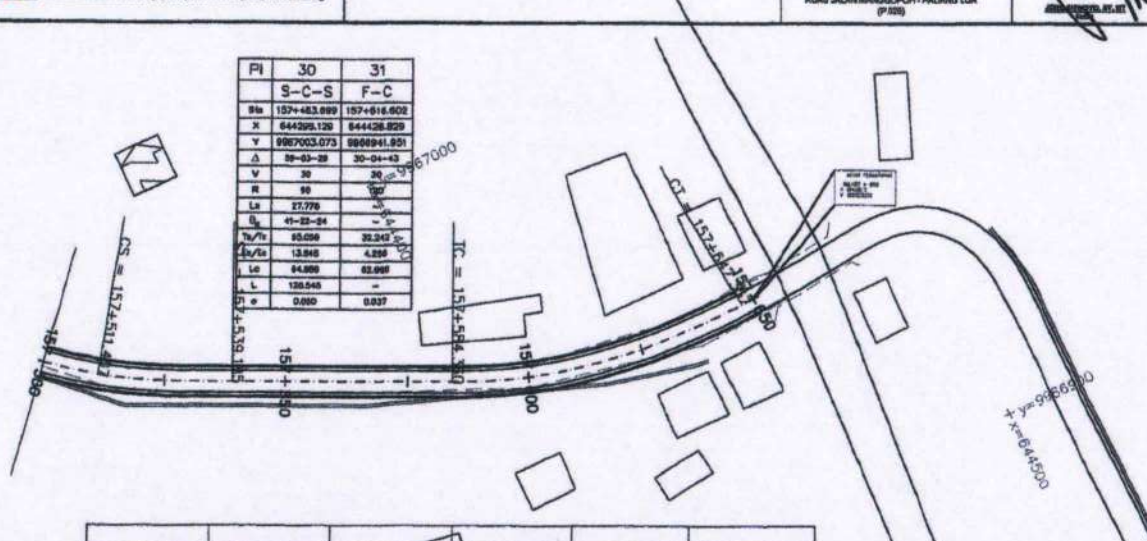

STA	ELEVAS		SUPER ELEVATION	IN	OUT
	Design Elevation	Existing Elevation			
157+500	944.075 944.192	944.142	[Profile Diagram]	IN	OUT
	944.205	944.155			
157+550	944.334 944.357	944.284	[Profile Diagram]	IN	OUT
	944.635	944.585			
157+600	944.987	944.937	[Profile Diagram]	IN	OUT
	945.338	945.288			
157+650	945.690	945.640	[Profile Diagram]	IN	OUT
STA	ELEVAS				
	Design Elevation	Existing Elevation			



PEMERINTAH PROVINSI SUMATERA BARAT
DINAS BINA MARGA, CIPTA KARYA DAN TATA RUANG
 Jalan Thammas Rana No. 1 Tgpg. (0701) 7051730 Pdg. (0701) 7051733 Padang

PEKERJAAN : PERENCANAAN TEKNIS PEKERJAAN MENDESAK DAN BENCANA ALAM
LOKASI : RUAS JALAN MANGGOPON - PADANG LIA (P.02)

Provinsi : Sumatera Barat
Lokasi : RUAS JALAN MANGGOPON - PADANG LIA (P.02)

Tinjauan Sarung Peralihan Mendadak dan Bencana Alam

(Handwritten signatures and stamps)

Judul Gambar :

STRIP RUP

No Lembar : **2**
 Tahun : **2023**
 Skala : **NSC**

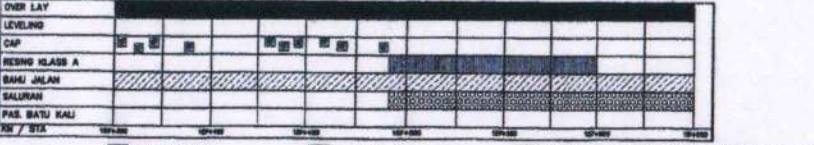
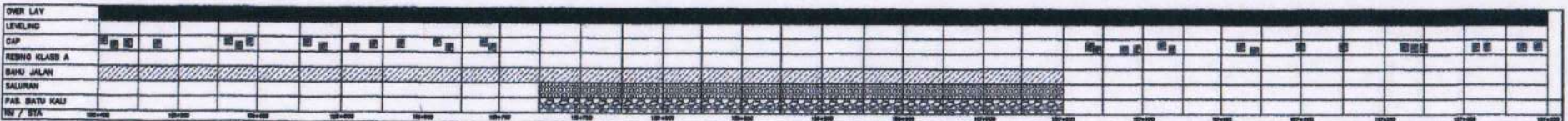
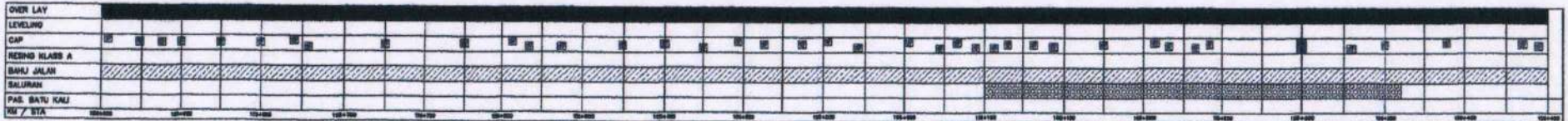
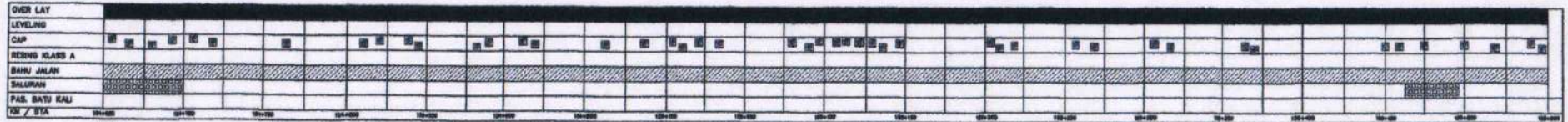



Disetujui Oleh: [Signature]
Menteri/Direktur: [Signature]

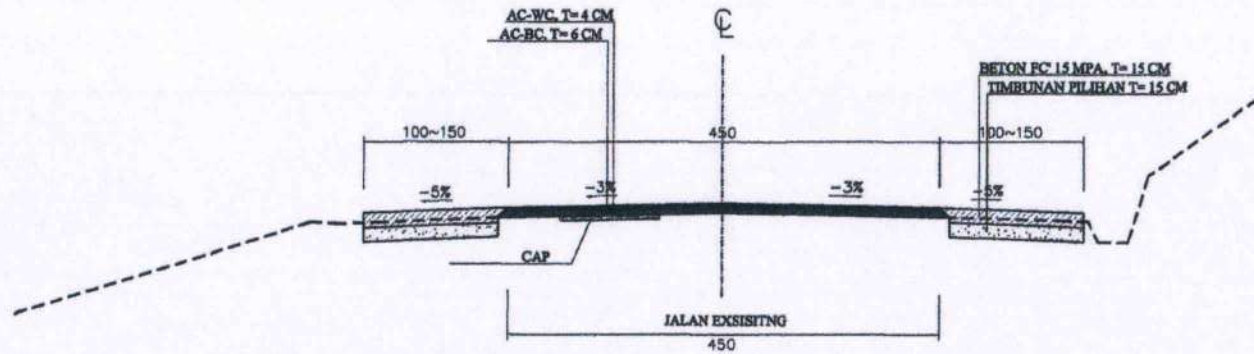

TYPICAL JALAN (STA 154+650 S/D 157+650) GRID $\geq 5\%$

SCALA 1:50

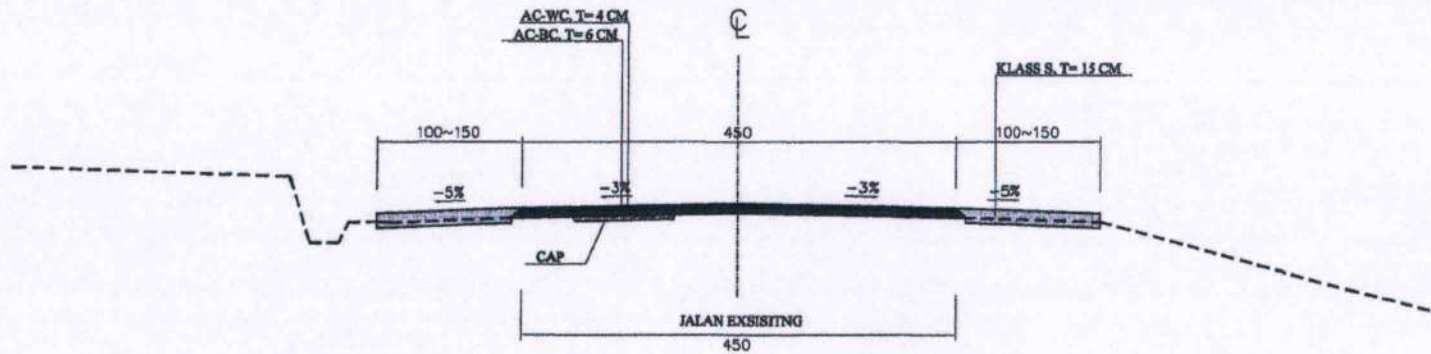

TYPICAL JALAN (STA 154+650 S/D 157+650) GRID $\leq 5\%$

SCALA 1:50



PEMERINTAH PROVINSI SUMATERA BARAT
DINAS BINA MARGA, CIPTA KARYA DAN TATA RUANG
Jalan Tamas Blava No. 1 Telp. (075) 7581750 Fax. (075) 7551752 Padang

PEKERJAAN : PERENCANAAN TEKNIS PEKERJAAN HENDAK DAN BENCANA ALAM
LOKAS : RUAS JALAN MANGGOPOH - PADANG LUA (P.025)

Propinsi :
Sumatra Barat
Lokasi :
RUAS JALAN MANGGOPOH - PADANG LUA
(P.025)

Survei Jalan Manggopoh dan Bencana Alam
Kantor Disiplin
Kantor Disiplin
Kantor Disiplin

Judul Gambar :
TYPICAL JALAN

No Lembar :
4
Tahun :
2023
Skala :
1:50

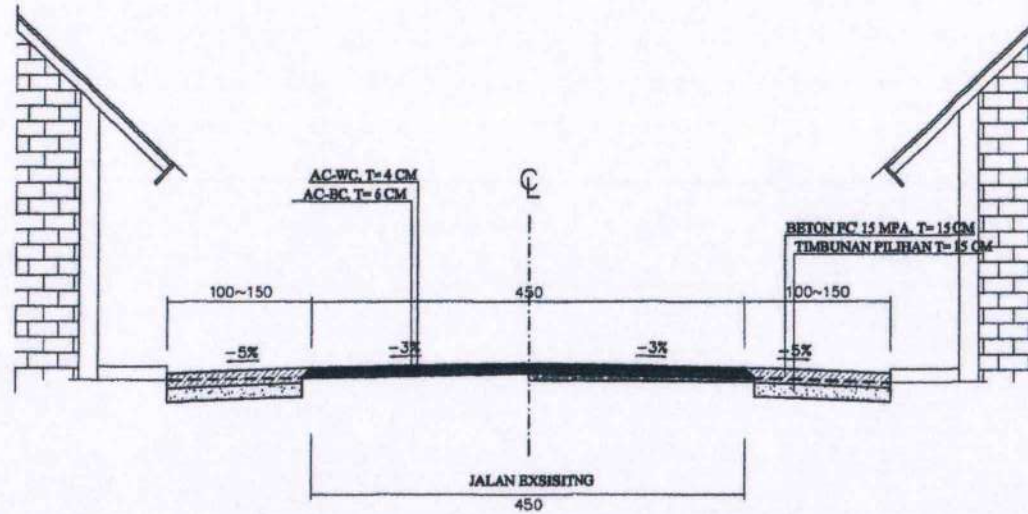

TYPICAL JALAN (STA 157+180 S/D 157+380)

SCALA 1:50

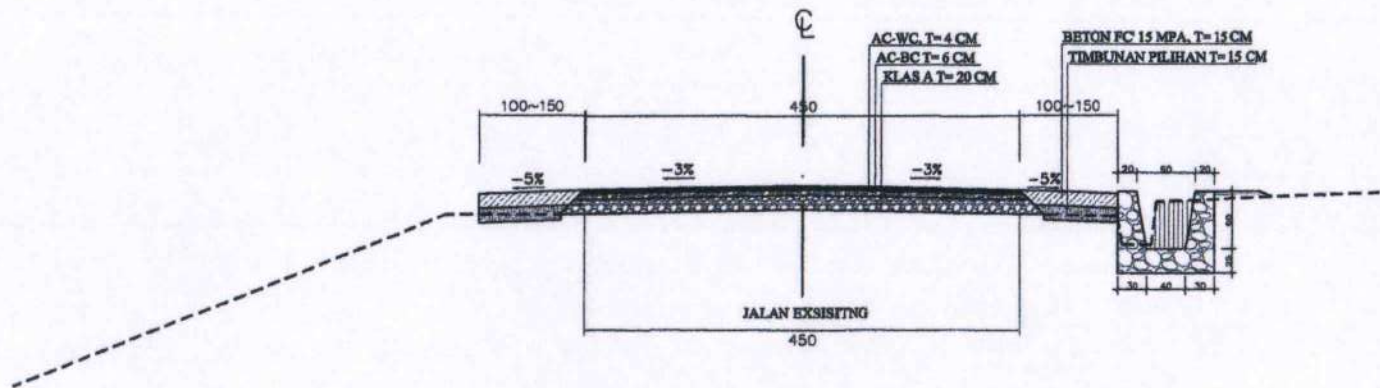

TYPICAL JALAN (STA 157+480 S/D 157+650)

SCALA 1:50



PEMERINTAH PROVINSI SUMATERA BARAT
DINAS BINA MARGA, CIPTA KARYA DAN TATA RUANG
Jalan Terasan Duren No. 1 Telp. (0751) 7881704 Fax. (0751) 7881703 Padang

PEKERJAAN : PERENCANAAN TEKNIS PEKERJAAN HENDAK DAN BENCANA ALAM
LOKASI : RUAS JALAN MANGGOPOH - PADANG LUA (P.020)

Propinsi :
Sumatra Barat
Lokasi :
RUAS JALAN MANGGOPOH - PADANG LUA
(P.020)

The Techn Survey Indonesia dan Berasmi Asim
Rencana Pelaksanaan
No. 01/2023
No. 01/2023

TYPICAL JALAN

No. Lembar :
3
Tahun :
2023
Skala :
1:50

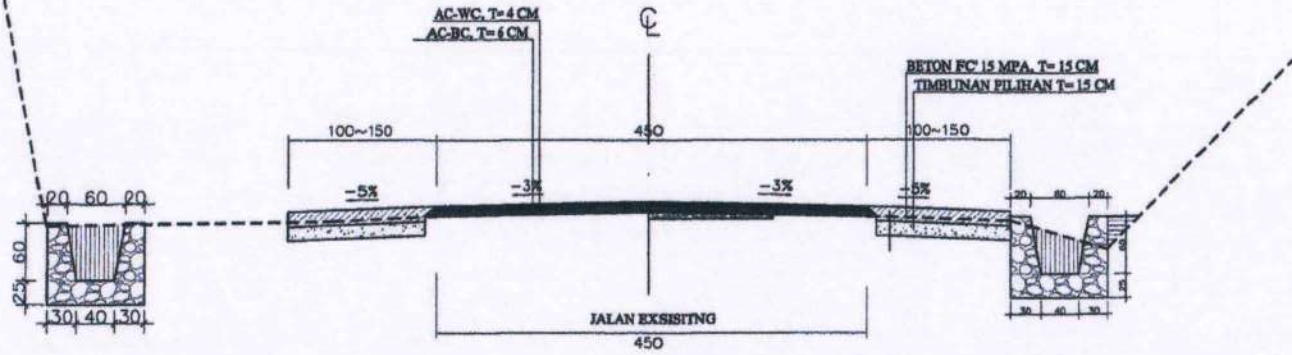

TYPICAL JALAN (STA 156+280 S/D 156+355)

SCALA 1:50

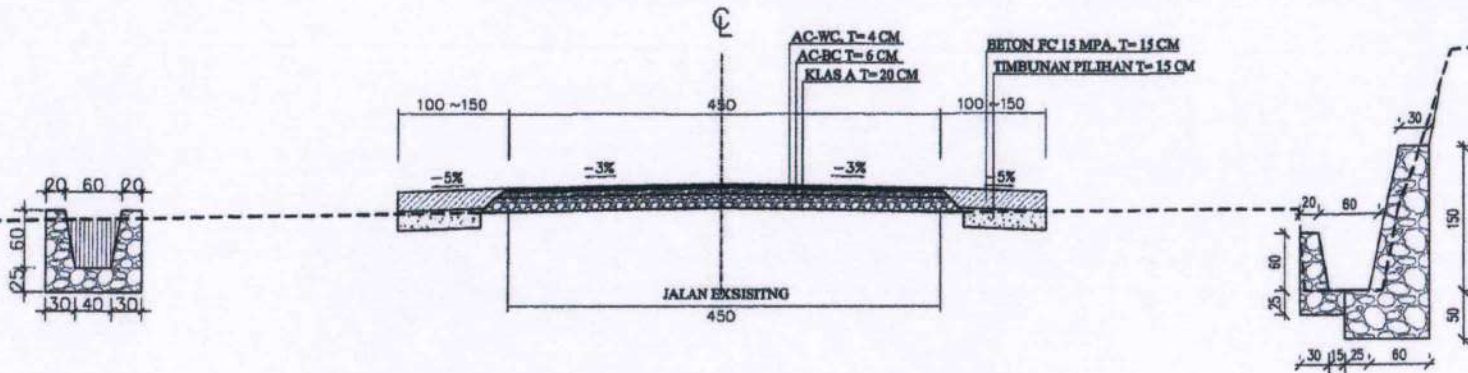

TYPICAL JALAN (STA 156+750 S/D 157+000)

SCALA 1:50



PEMERINTAH PROVINSI SUMATERA BARAT
DINAS BINA MARGA, CIPTA KARYA DAN TATA RUANG
Jalan Yosudi Siregar No. 1, Padang, (0751) 7051750 Fax. 07513 101743 Padang

PEKERJAAN : PERENCANAAN TEKNIS PEKERJAAN BENCOSAK DAN BENCANA ALAM
LOKASI : RUAS JALAN MANGGOPPOH - PADANG LUA (P.029)

Provinsi :
Sumatra Barat
Lokasi :
RUAS JALAN MANGGOPPOH - PADANG LUA
(P.029)

Teknik Survey Pekerjaan Mendekat dan Bencosa Alam
Bencana Hidrometeorologi
Jenis Gambar :
Tipe :
Tanggal :
Disetujui Oleh :
M. H. H. H. H.

TYPICAL JALAN

REVISI :
2
TANGGAL :
2023
Skala :
1:50

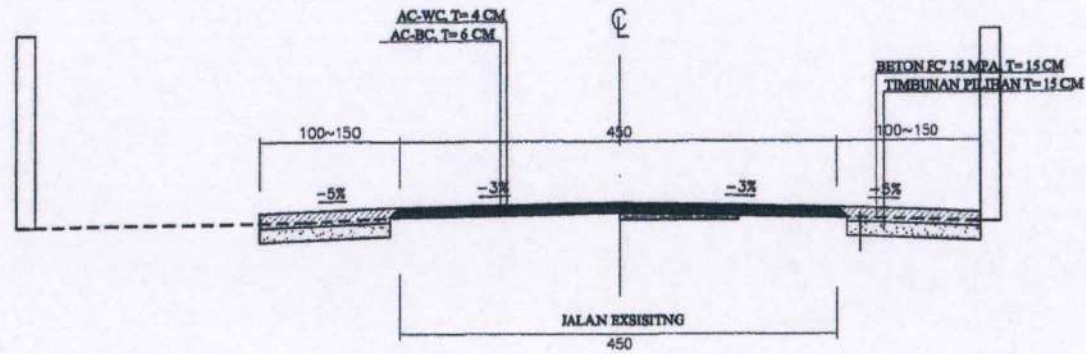

TYPICAL JALAN (STA 155+580 S/D 156+100)

SCALA 1:50



PEMERINTAH PROVINSI SUMATERA BARAT
**DINAS BINA MARGA, CIPTA KARYA,
dan TATA RUANG**
JL. TAMAN SISWA NO. 01 PADANG TELP.0751-7051700 / 7051758

PROGRAM : PENYELENGGARAAN JALAN PROPINSI
SUB KEGIATAN : PENYUSUNAN RENCANA, KEBIJAKAN, STRATEGI PEMBANGUNAN JALAN
SERTA PERENCANAAN TEKNIK PENYELENGGARAAN JALAN DAN JEMBATAN
PAKET : CORE TEAM PERENCANAAN DAN PENDAMPINGAN TEKNIK BINA MARGA
SUB PEKERJAAN : DESAIN PENANGANAN SEMENTARA / MENDESAK JALAN TERBAN MANGGOPOH -
PADANG LUAR (P.025)
LOKASI : NAGARI SUNGAI LANDIA KIL. 160+100 & KM. 160+950
TAMUN : 2023

PT. LARAS SEMBADA
Architect - Engineering and Management Consultant



CORE TEAM

DIREKSI

DI PERIKSA

ABASU, ST
TAMUN

H. KURNIAWAN, ST
TAMUN

JUDUL GAMBAR

TYPICAL PERKERASAN
KM. 160 +100

NOMOR
LEMBAR

SKALA

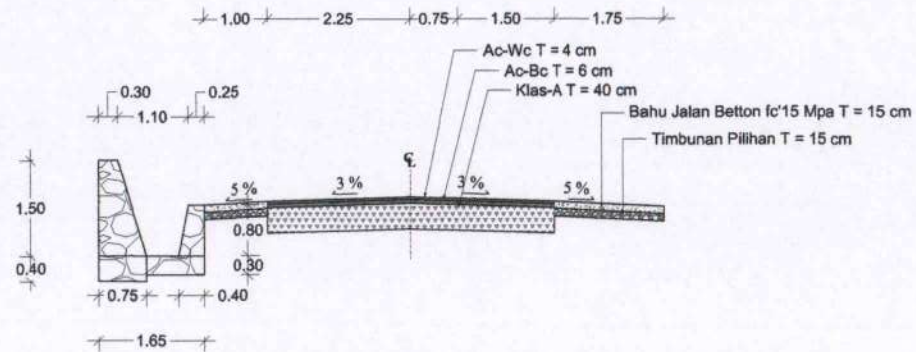

Typical I



PEMERINTAH PROVINSI SUMATERA BARAT
**DINAS BINA MARGA, CIPTA KARYA,
 dan TATA RUANG**
 JL. TAMAN SISWA NO. 01 PADANG TELP.0751-7051700 / 7051758

PROGRAM : PENYELENGGARAAN JALAN PROPINSI
 SUB KEGIATAN : PENYUSUNAN RENCANA, KEBIJAKAN, STRATEGI PEMBANGUNAN JALAN
 SERTA PERENCANAAN TEKNIS PENYELANGGARAN JALAN DAN JEMBATAN
 PAKET : CORE TEAM PERENCANAAN DAN PENDAMPINGAN TEKNIS BINA MARGA
 SUB PEKERJAAN : DESAIN PENANGANAN SEMENTARA / MENDESAK JALAN TERBAN MANGGOPOH -
 PADANG LUAR (P.025)
 LOKASI : NAGARI SUNGAI LANDIA KM. 160+198 & KM. 160+958
 TAHUN : 2023



PT. LARAS SEMBADA
 Industri - Engineering and Management Consultant

CORE TEAM

DIREKSI ANAK
 [Signature]

DI PERIKSA
 [Signature]

JUDUL GAMBAR

TYPICAL BORED PILE
 KM. 160 +100

SKALA

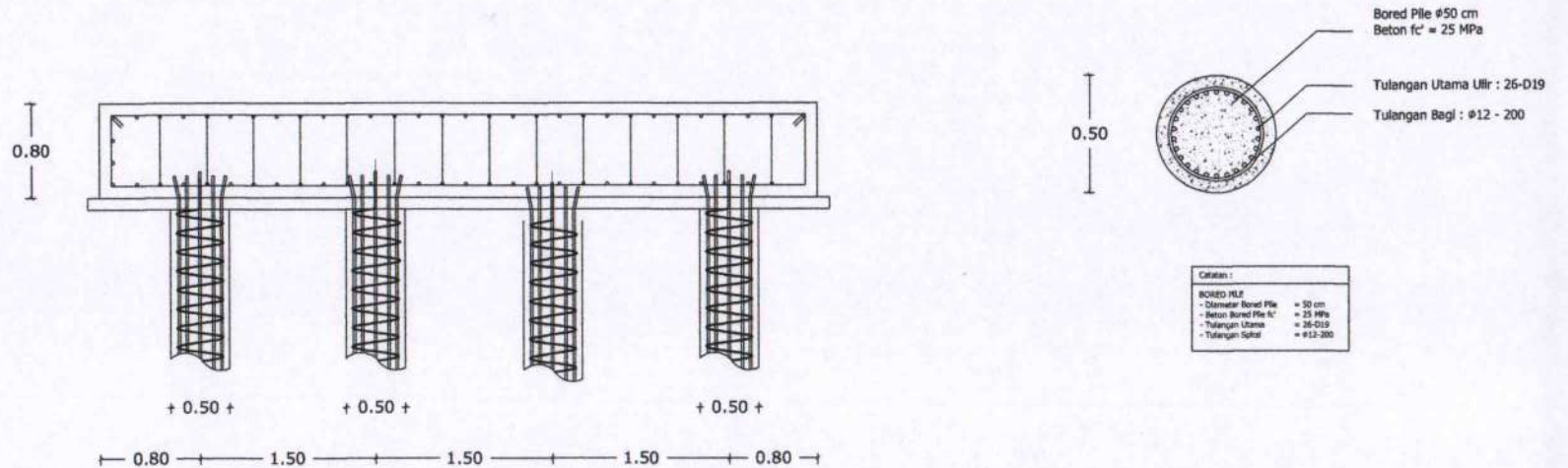



PEMERINTAH PROVINSI SUMATERA BARAT
**DINAS BINA MARGA, CIPTA KARYA,
 dan TATA RUANG**
 JL. TAMAN SISWA NO. 01 PADANG TELP.0751-7051700 / 7051758

PROGRAM : PENYELENGGARAAN JALAN PROPINSI
 SUB KEGIATAN : PENYUSUNAN RENCANA, KEBIJAKAN, STRATEGI PEMBANGUNAN JALAN
 SERTA PERENCANAAN TEKNIS PENYELANGGARAN JALAN DAN JEMBATAN
 PAKET : CORE TEAM PERENCANAAN DAN PENDAMPINGAN TEKNIS BINA MARGA
 SUB PEKERJAAN : DESAIN PENANGANAN SEMENTARA / MENDESAK JALAN TERRAN MANGGOPOH -
 PADANG LUAR (P.025)
 LOKASI : NAGARI SUNGAI LANDIA KM. 160+100 & KM. 160+950
 TAHUN : 2023



DIREKSI
 ARSITRAK
 JALAN

CORE TEAM

DIPERIKSA
 E. KURNIAWATI DEWI, MT
 DESA

JUDUL GAMBAR : PENULANGAN RWC
 KM. 160 +100
 NOMOR
 LEMBAR
 SKALA

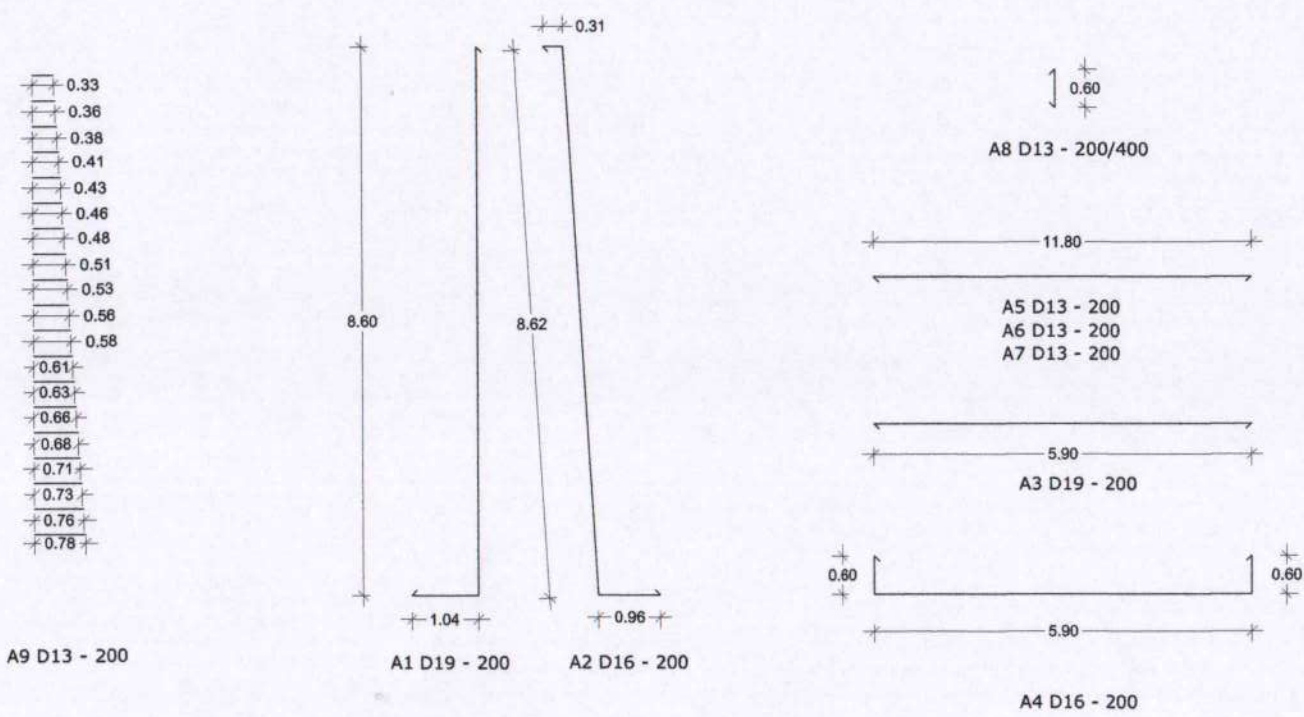



PEMERINTAH PROVINSI SUMATERA BARAT
**DINAS BINA MARGA, CIPTA KARYA,
 dan TATA RUANG**
 JL. TAMAN SISWA NO. 01 PADANG TELP.0751-7051700 / 7051758

PROGRAM : PENYELENGGARAAN JALAN PROPINSI
 SUB KEGIATAN : PENYUSUNAN RENCANA, KEBIJAKAN, STRATEGI PEMBANGUNAN JALAN
 SERTA PERENCANAAN TEKNIS PENYERLANGGARAN JALAN DAN JEMBATAN
 PAKET : CORE TEAM PERENCANAAN DAN PENDAMPINGAN TEKNIS BINA MARGA
 SUB PEKERJAAN : DESAIN PENANGANAN SEMENTARA / MENDESAK JALAN TERBAN MANGGAPOH -
 PADANG LUAR (P.025)
 LOKASI : NAGARI SUNGAI LANDIA KIL. 160+100 & KIL. 160+950
 TAHUN : 2023

PT. LARAS SEMBADA
 Insinyur - Engineering and Design Creative



CORE TEAM

DIREKSI
 ARIANIL ET AL

PERIKSA
 H. KURNIAWAN, S.T., M.T.

JUDUL GAMBAR

TYPICAL RWC
 KM. 160 +100

NOMOR
 LEMBAR

SKALA

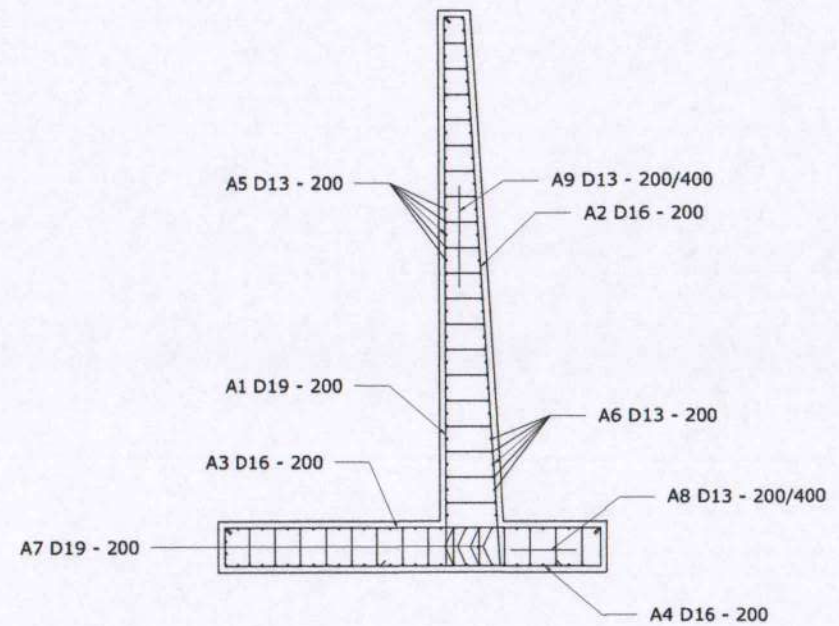
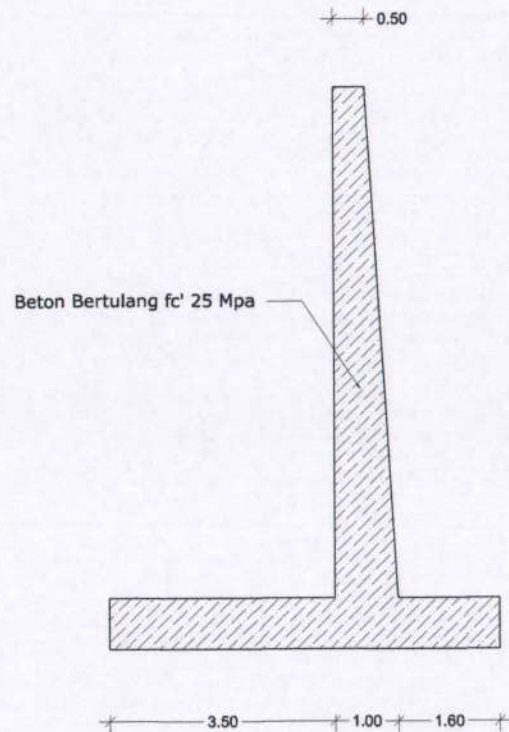

Detail pembesian RWC
 $H = 8.80 \text{ m}$ $Pj = 12 \text{ m}$



PEMERINTAH PROVINSI SUMATERA BARAT
**DINAS BINA MARGA, CIPTA KARYA,
 dan TATA RUANG**
 JL. TAMAN SISWA NO. 01 PADANG TELP.0751-7051700 / 7051758

PROGRAM : PENYELENGGARAAN JALAN PROPINSI
 SUB KEGIATAN : PENYUSUNAN RENCANA, KEBIJAKAN, STRATEGI PEMBANGUNAN JALAN
 SERTA PERENCANAAN TEKNIS PENYELANGGARAN JALAN DAN JEMBATAN
 PAKET : CORE TEAM PERENCANAAN DAN PENDAMPINGAN TEKNIS BINA MARGA
 SUB PEKERJAAN : DESAIN PENANGANAN SEMENTARA / MENDESAK JALAN TERBAN MANGGOPOH -
 PADANG LUAR (P.025)
 LOKASI : NAGARI SUNGAI LANDIA KM. 160+100 & KM. 160+950
 TAHUN : 2023



CORE TEAM

DIREKSIAN/AM
 A. HANIK ST
 PENYELANGGARAN

DI PERIKSA
 H. RUPYANTO H. DEWISMA MT
 PENYELANGGARAN

JUDUL GAMBAR

CROSS SECTION
 KM. 160 +100

NOMOR
 LEMBAR

SKALA

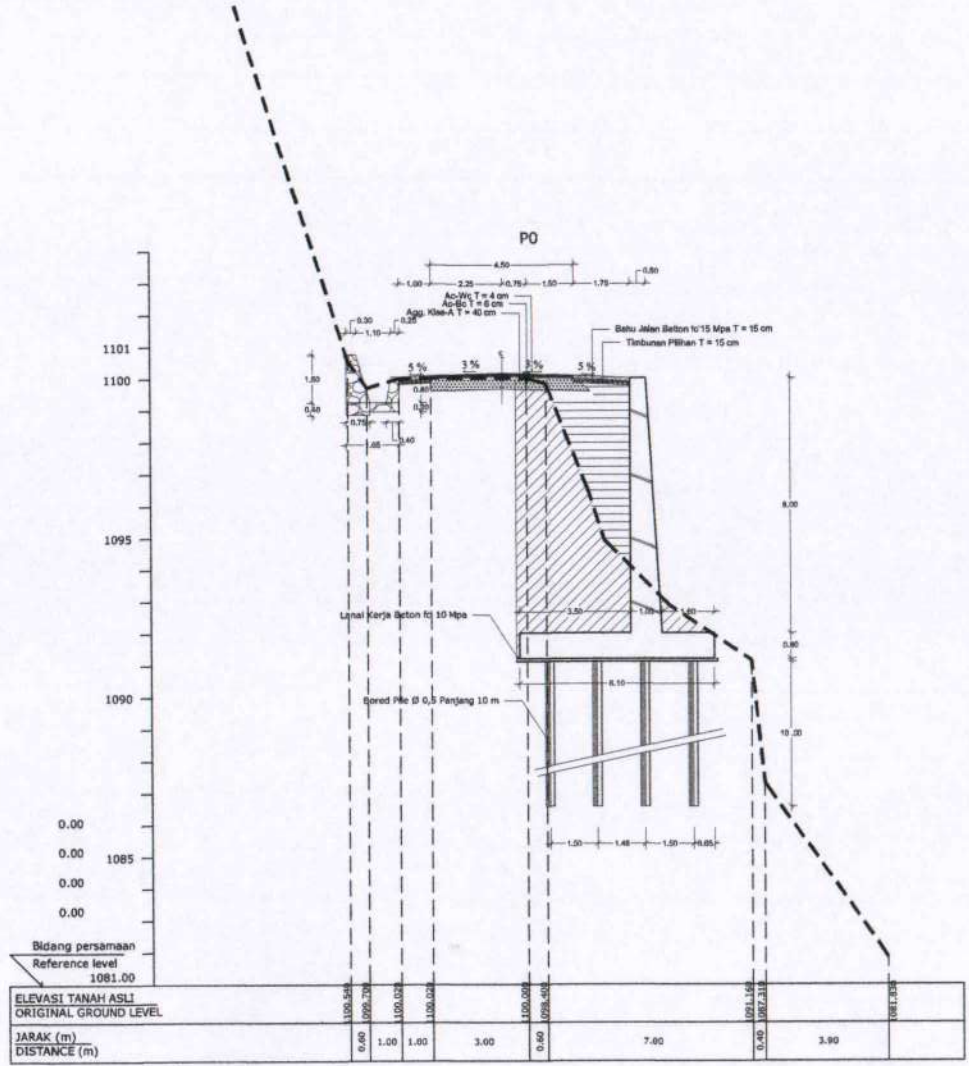



**PEMERINTAH PROVINSI SUMATERA BARAT
DINAS BINA MARGA, CIPTA KARYA DAN TATA RUANG**

Jalan Taman Siswa No. 1 Telp. (0751) 7051756 Fax. (0751) 7051783 Padang

GAMBAR RENCANA

PEKERJAAN:

PERENCANAAN TEKNIS PEKERJAAN MENDESAK DAN BENCANA ALAM

LOKASI :

RUAS JALAN MANGGOPOH - PADANG LUA (P.025)

TAHUN ANGGARAN 2023